

# OPERATION MANUAL

## MOB 112

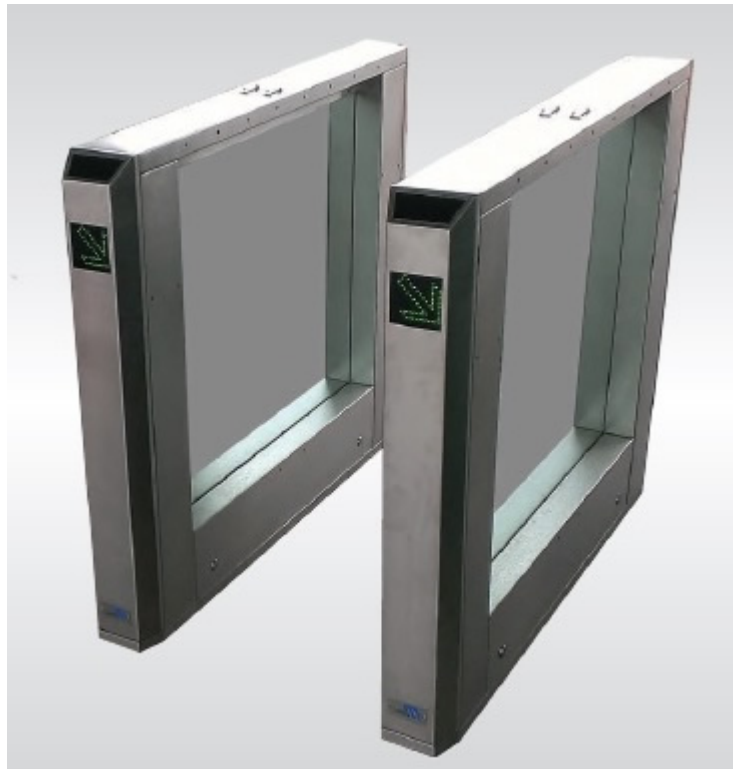

**Contents**

**1 GENERAL .....4**

    1.1 Information regarding the operating instruction .....4

    1.2 Limitation of liability .....4

    1.3 Warranty.....5

**2 TECHNICAL DATA .....6**

    2.1 Dimension .....6

    2.2 Specification .....6

**3 DESIGN AND FUNCTION.....7**

    3.1 Basic Component Design .....7

    3.2 Lane Configuration .....8

    3.3 Basic Function.....8

    3.4 System Component.....9

**4 ASSEMBLY AND INSTALLATION .....10**

    4.1 Safety .....10

    4.2 Special Tools Require .....10

    4.3 Required Step .....10

    4.4 Foundation and Empty Conduit.....10

    4.5 Foundation and Conduit Layout .....11

    4.6 Unlocking The Housing Assembly.....13

    4.7 Installation on to the floor / ground .....15

**5 ELECTRICAL CONNECTION .....16**

    5.1 Electrical Component – Location.....16

        5.1.1 PE Beam Location.....16

        5.1.2 Internal Component.....17

        5.1.3 Crossing Cable .....18

        5.1.4 Connecting Customer Wiring / Signal to Open (Card Access Control Signal).....18

**6 START UP AND OPERATION.....19**

    6.1 Start-up .....19

    6.2 Operation .....19

        6.2.1 Mode of operation .....19

        6.2.2 Operation Logic .....20

**7 MAINTENANCE .....23**

**8 MALFUNCTIONS.....24**

    8.1 Malfunction table – Gates.....24



9	PARE PARTS .....	26
10	ELECTRICAL SCHEMATIC DIAGRAM – AT ATTACHMENT .....	28

## **1 GENERAL**

### **1.1 Information regarding the operating instruction**

These operating instructions provide crucial information on handling of MAGNETIC MOB112. Pre-requisite for safe working is the observance of all specified safety notes and instructions. In addition, the local accident prevention regulations valid at the barrier's area of application and general safety regulations have to be complied with. Carefully read the operating instructions before starting any work! They are a product component and must be kept in direct proximity of the barrier, well accessible to the personnel at all times. When passing the barrier on to third parties, the operating instructions must also be handed over. Components from other suppliers may have their own safety regulations and instructions for use. These must also be observed.

### **1.2 Limitation of liability**

All specifications and notes in these operating instructions were compiled with consideration to the valid standards and regulations, the state of the art as well as to our long-standing knowledge and experience.

The manufacturer is not liable for damages caused by:

- Non-observance of the operating instructions
- Improper use
- Deployment of non-trained personnel
- Arbitrary modifications
- Technical changes
- Use of non-approved spare and wear parts.

The actual scope of supply may differ from the explanations and illustrations described in this manual in case of special designs, if additional order options are made use of, or due to latest technical changes. Incidentally, the responsibilities agreed upon in the delivery contract, the general terms and conditions as well as the manufacturer's conditions of delivery and the statutory provisions valid at the time of contract conclusion shall apply.



### 1.3 Warranty

Subject to the condition that the operating instructions are observed, and that no inadmissible operations are carried out on the technical equipment, and that the installation has suffered no mechanical damage, MAGNETIC guarantees all mechanical and electrical components for the duration as stated in our standard terms of sales and delivery or as contractually agreed in writing.

## 2 TECHNICAL DATA

### 2.1 Dimension

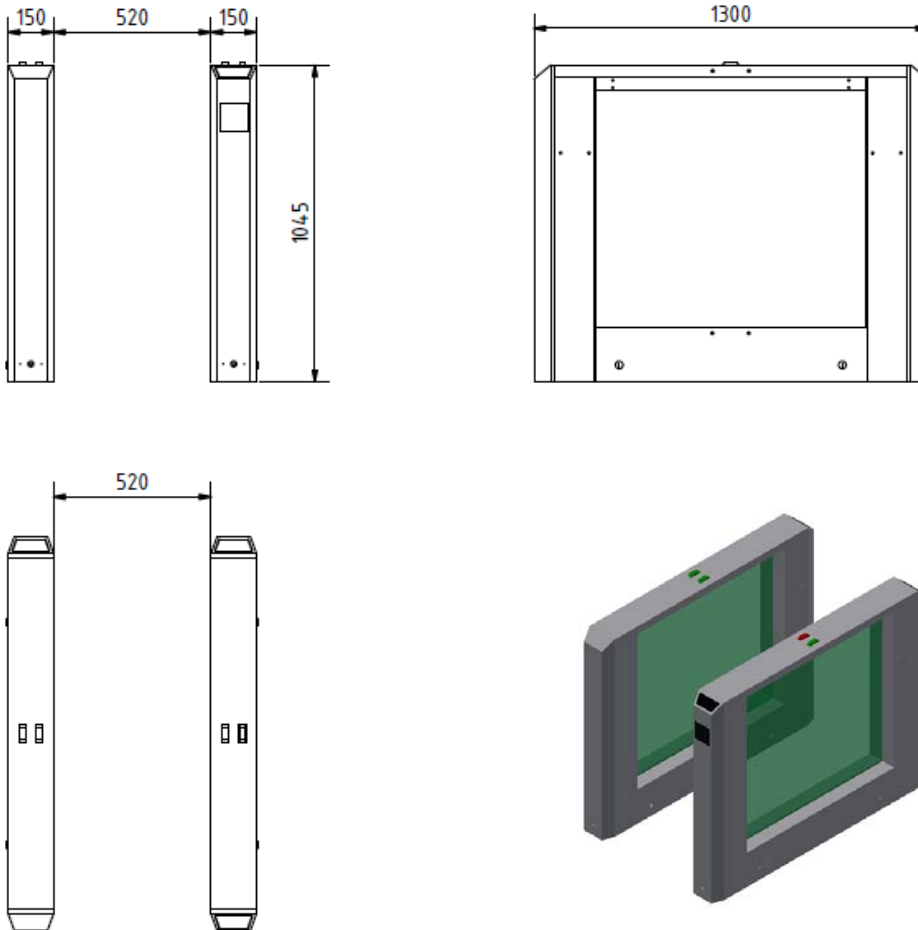

### 2.2 Specification

• Voltage	: 110VAC-240VAC @ 50hz/60hz
• Power Consumption	: 10W
• Sensor	: Photo Electric IR Sensor, 8 pairs
• Operating Temperature	: -30°C - 45°C
• IP rating (protection class)	: IP 32
• Dimension	: 130mm(L) x 1045mm(H) x 150mm(W)
• Passage Width (Standard Lane Only)	: 520mm
• Housing Material	: Stainless Steel 304 / 316 / Powder Coated
• Pictogram	: Green for valid access, Red for Invalid access
• Gate End Display	: Yes
• Type of command signal and integration	: Dry contact or RS232
• Directional control	: Yes, by Dry contact or RS232

**3 DESIGN AND FUNCTION**

**3.1 Basic Component Design**

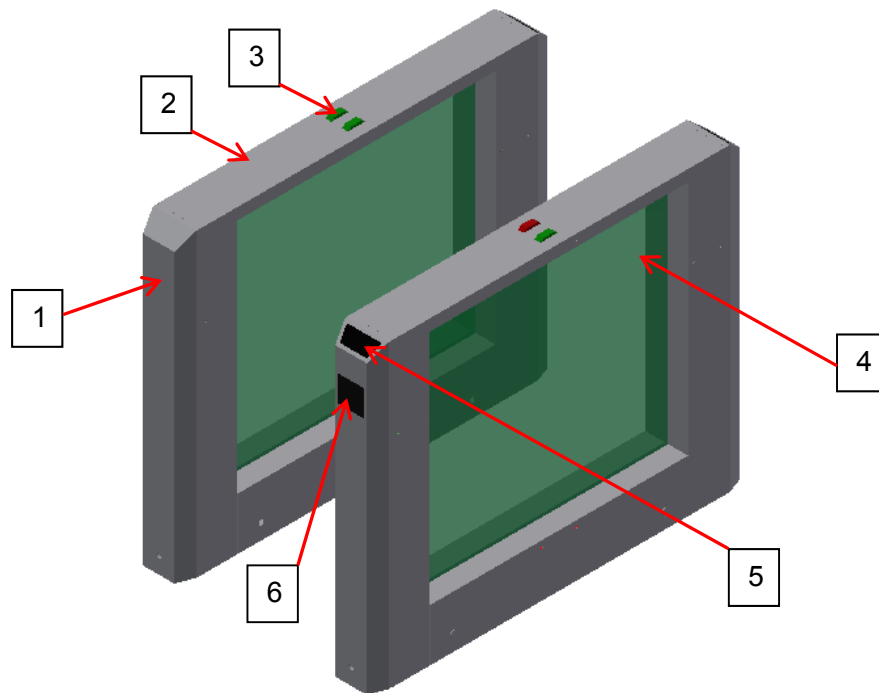

Figure 4.1

1. Housing Front Module
2. Housing Top Module
3. Pictogram Green or Red
4. Clear Tempered Glass
5. Reader Face Plate
6. Gate End Display

### 3.2 Lane Configuration

The pedestrian barrier can be supplied in the following modules:

- Basic module
- End module
- Center module

The basic module has got a master function, the end module a slave function and the others have got both, master and slave function.

For a lane, one module with slave and one with master function is always required. Each lane works independently.

The number of lanes can be expanded optionally by center and transition modules.

The following Fig. shows 4 lane configurations.

● = MBC (Master)

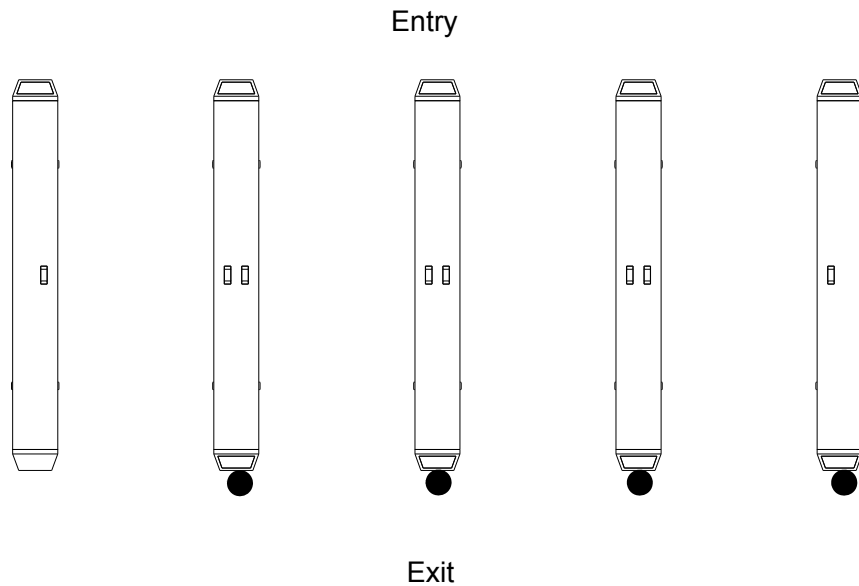

### 3.3 Basic Function

The pedestrian barrier MOB is used for a fast access control of pedestrians e.g. at the reception area of public buildings, hotels, companies or museums. With suitable roofing, it can be used out of doors, e.g. in sports stadiums.

The modular system permits numerous different lane configurations.



Basically, the pedestrian barrier can be used in both directions. In multi-lane installations with high throughput rates, the entry and exit lanes can also be configured for one-way passage.

### 3.4 System Component

The MBC-110 and MBC 120 logic controller are connected using CAN bus. A total of 8 infrared light barriers and two gate end displays are connected to digital inputs and outputs.

For the customer, there are digital inputs to grant an access of the pedestrian barrier, e.g. for a card reader, The power supply for the controllers is provided by a power supply with two output voltages, 24 VDC and 12VDC.

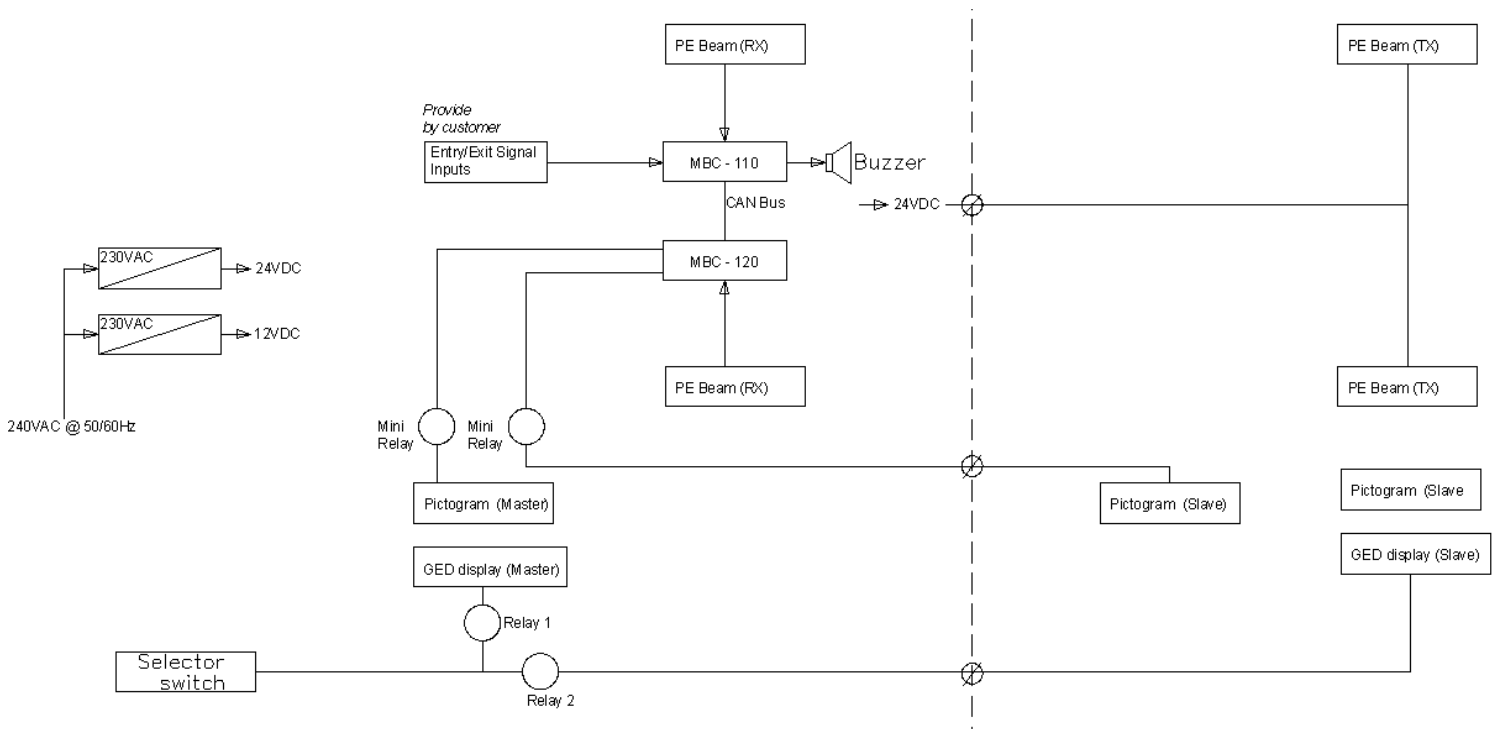

## 4 ASSEMBLY AND INSTALLATION

### 4.1 Safety

#### **Personal protective equipment**

The following must be worn during all assembly and installation work:

- Work clothes
- Protective gloves
- Safety shoes.

### 4.2 Special Tools Require

Following special tools are required for assembly and installation works:

- Torque wrench (15 Nm)

### 4.3 Required Step

The following procedures have to be observed during assembly and installation:

- Laying the foundation
- Installing the empty conduits
- Unpacking the pedestrian barrier
- Mounting the pedestrian barrier on the foundation
- Assemble glass wings and anti-climb panels.
- Connect pedestrian barrier electrically, wire modules.
- Assemble housing.

### 4.4 Foundation and Empty Conduit

Before assembling the pedestrian barrier, if it is a new construction building then a foundation has to be laid and empty conduits have to be installed otherwise **if the pedestrian barrier to be install on to existing building then it is recommended that the Main Contractor and Building owner shall discuss further on the method of installation.**

## 4.5 Foundation and Conduit Layout

### Typical Single Line Diagram

● = MBC (Master)

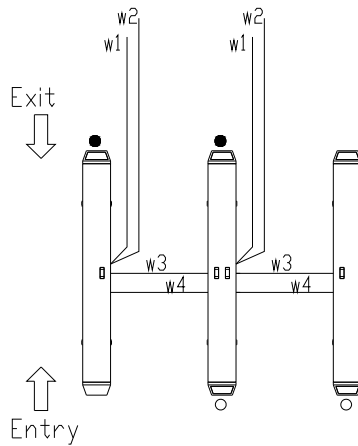

Wiring and Conduiting Table (typical wiring layout)			
Name	Conduit size	Cable Consist of	Remark
w1	25mm dia x 1	3c 1.5mm sq	240VAC @50fz, 13A
w2*	32mm dia x 1	TBA 1 x CAT 5E	TBA by system integrator / ACS Control Signal (Entry / Exit)
w3	25mm dia x1	2 x CAT 5E	24vdc Pictogram Gate End Display
w4*	25mm dia x 1	TBA	Extra Conduit for ACS

Note: \* TBA by access control system integrator

**Typical Layout for Conduit Location**

● = MBC (Master)

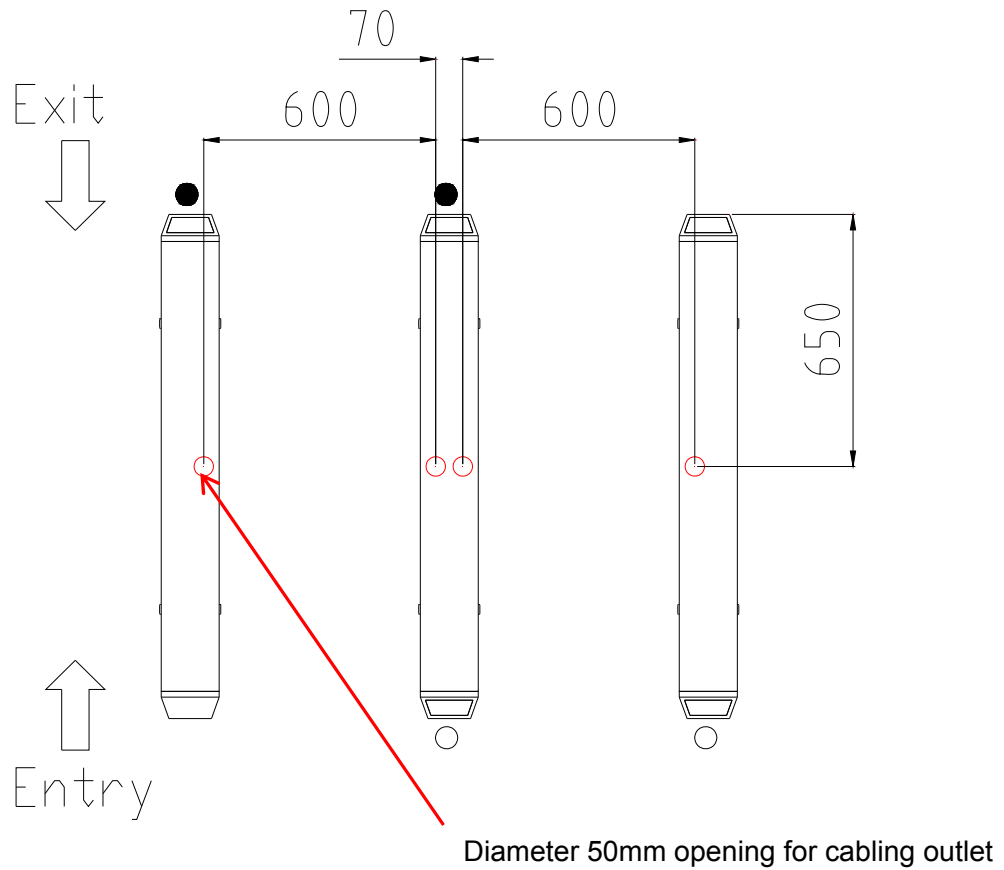

## 4.6 Unlocking The Housing Assembly

### 4.6.1.1 Remove the Front Module

- To remove the front housing from its main housing as shown below.

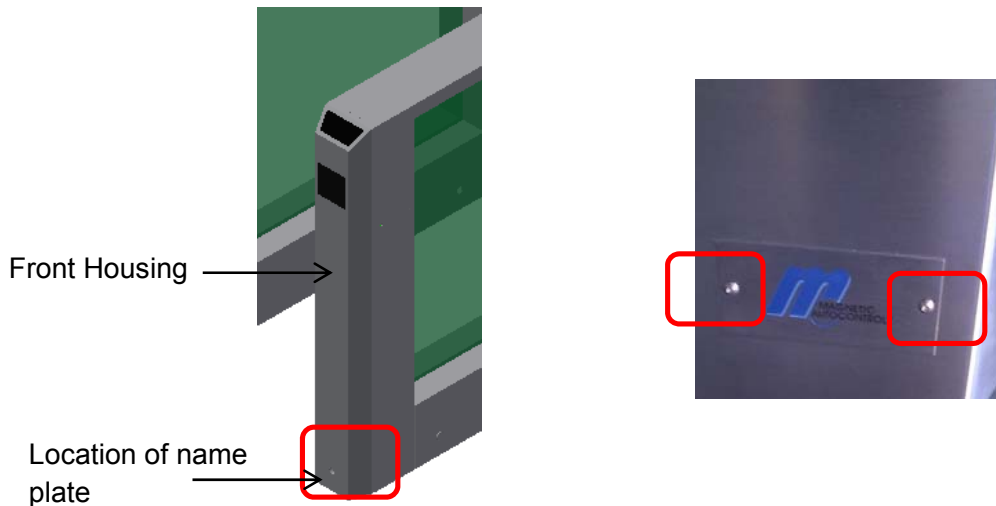

- Use a correct size Allen/Hex Key to remove the screw at the Magnetic Name plate as show below, after remove the screw, please keep it in a secure place to avoid missing. Location of name is as shown above
- After the Name plate is removing and locate at secure place, you will then saw a larger bolt as shown below, use the correct size Allen Key Set again to remove the screw.



- After the larger bolt is removed, the front housing can be disassemble or remove from the main housing by first pull / push the front housing toward the top direction as shown.

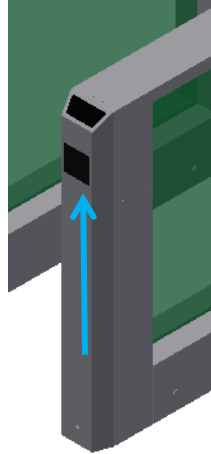

- To install the front housing back, reverse the procedure shown on step above.

#### 4.6.1.2 Remove the bottom side cover or the back bottom cover

- Use the Euro 2500 Key provided to unlock the lock at the cover.



Inside Bottom Cover  
(consist of 2 lock for  
each cover)

- After unlock, you main remain the key inside the lock to assist open up the cover by pull upward the cover and remove the cover from it position as shown on the step below. NOTE: please take extra care to open this cover as it may scratch the housing.



- After all cover has been dissembled or remove, the gate can be now installed.

#### 4.7 Installation on to the floor / ground

- Location of mounting hole the MOB is as shown below.
- Do marking according to the dimension given and drill suitable hole size for anchor / masonry bolt size of M12 x 100mm (**NOTE: length of bolt depend on local availability and must depend also on the type of concrete floor foundation**)

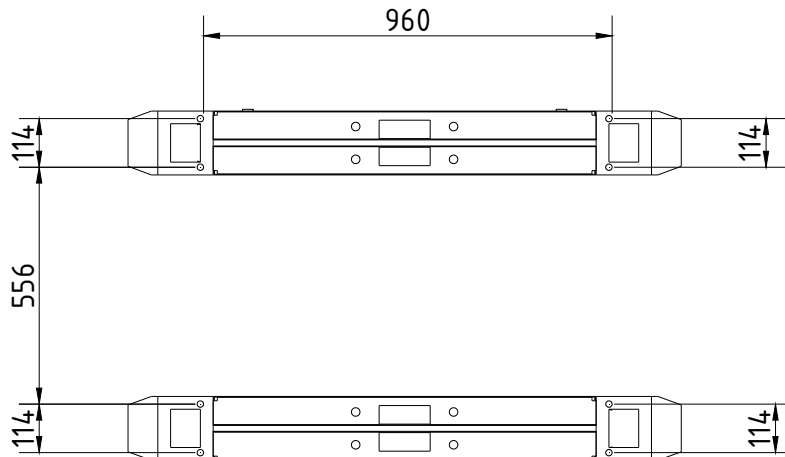

5 ELECTRICAL CONNECTION

5.1 Electrical Component – Location

5.1.1 PE Beam Location

● = MASTER

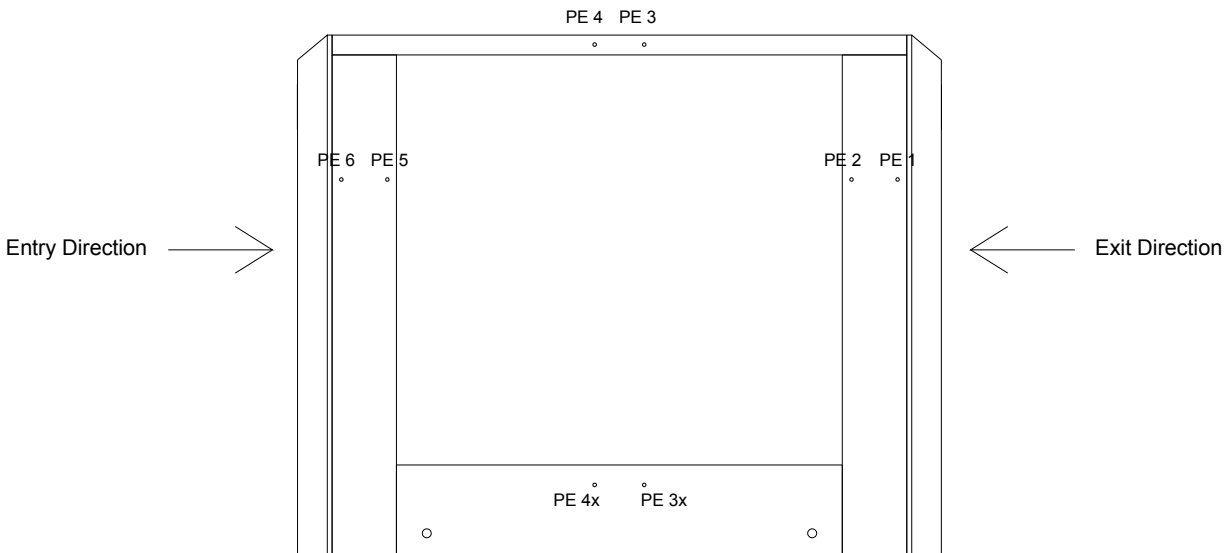
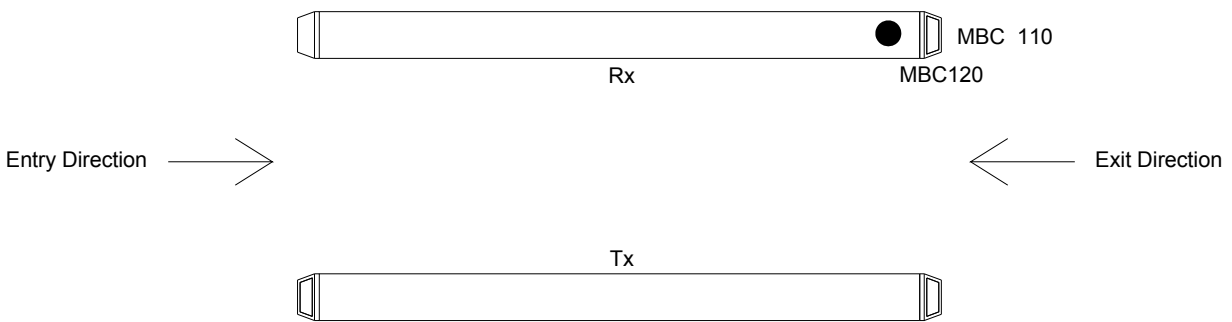



### 5.1.2 Internal Component

MASTER CONTROL PANEL

SLAVE CONTROL PANEL

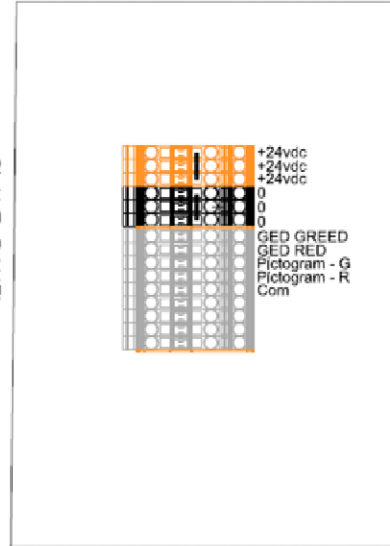
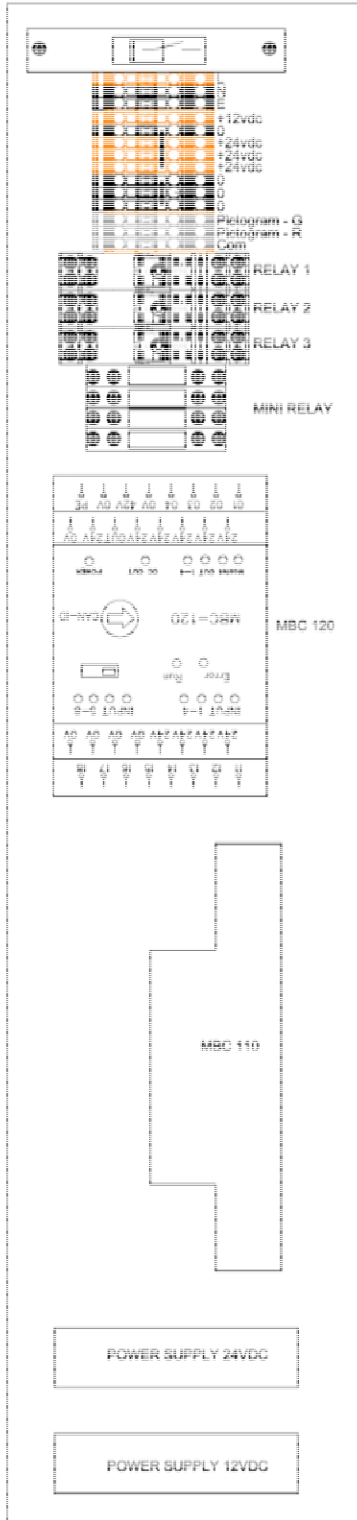

### 5.1.3 Crossing Cable

CROSSING CABLE

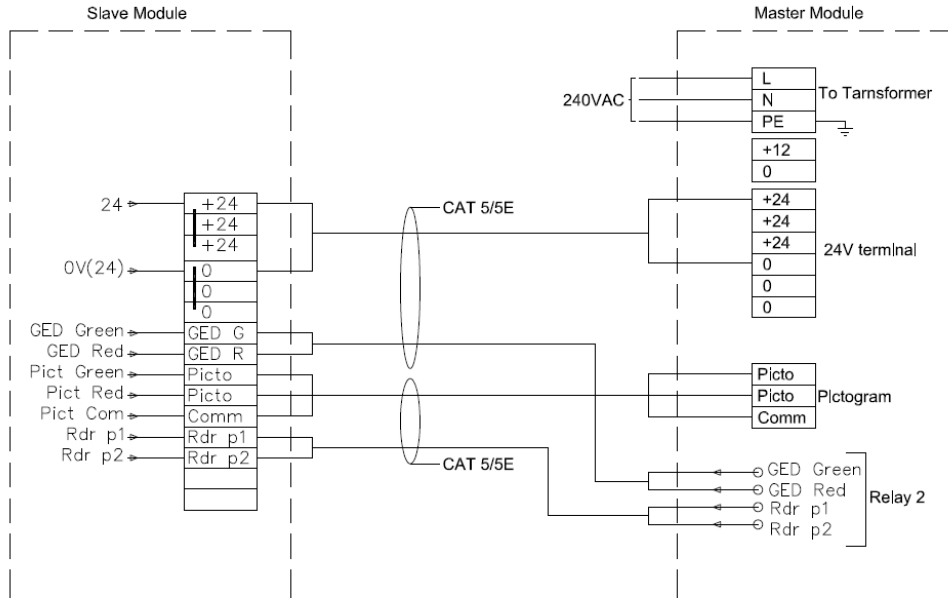

### 5.1.4 Connecting Customer Wiring / Signal to Open (Card Access Control Signal)

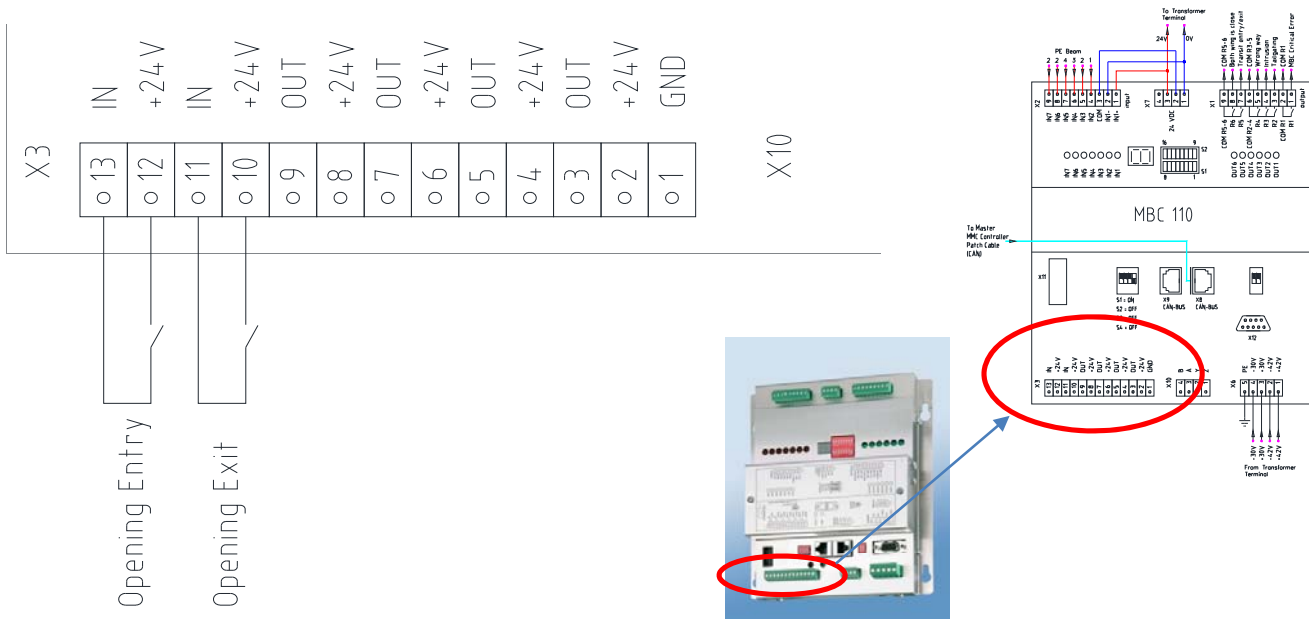

**Note: 1, Dry contact pulse signal ONLY (0.5sec to 1sec)**

## 6 START UP AND OPERATION

### 6.1 Start-up

#### Inspection prior to initial start-up

A must be performed prior to initial startup:

- Check wiring emergency input IN1. .
- Check connection of digital inputs IN9 and IN10.
- Check connection of relays outputs 1 to 6. (if any)
- The program mode is select accordingly.

### 6.2 Operation

#### 6.2.1 Mode of operation

MOB 112 design to operate in 3 different mode:

1. Bidirectional mode – passenger can use both the direction with valid access
2. Entry mode only – passenger can use only Entry direction only
3. Exit mode only – passenger can use only Exit direction only

Switching the mode direction can be done by a control switch below.



#### NOTE







Dual = Bidirectional mode – Both GED will show Green arrow

Entry = Entry only – Entry GED will show Green arrow, Exit will show Red Cross

Exit = Exit only - Exit GED will show Green arrow, Entry will show Red Cross

## 6.2.2 Operation Logic

### LEGEND

-  Sensor Array
-  Pedestrian (various color)
-  Valid Signal
-  Multiple Valid Signal
-  MOB allow one person to enter the gate and exit the gate or vice versa
-  MOB allow multi person to enter the gate and exit the gate or vice versa
-  Alarm (blinking) RED, Fraud detected, i.e. tailgating, wrong way or intrusion.

### 6.2.2.1 Single Access

Upon received of single signal, pictogram will turn GREEN to allow a person to access the gate, once the person exiting the gate, pictogram GREEN will turn OFF

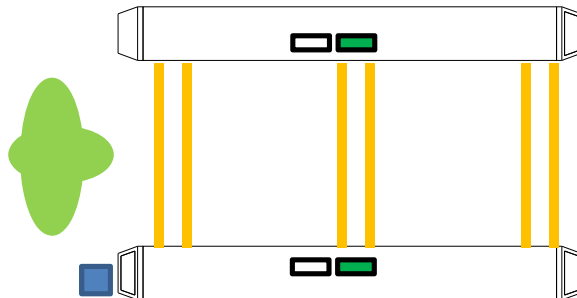

### 6.2.2.2 Multiple Access

Pictogram will first Turn GREEN and once received of second valid signal, it will turn OFF and GREEN again to allow second person enter the gate or vice versa

Once all the person exiting the gate, pictogram GREEN will turn OFF

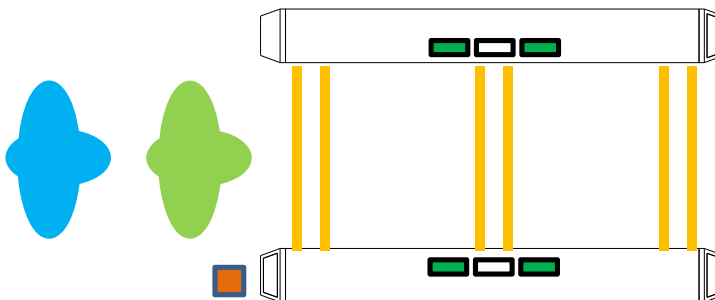

**6.2.2.3 Tailgating**

Upon received of single valid signal, pictogram GREE will turn ON to allow one person to enter the gate.

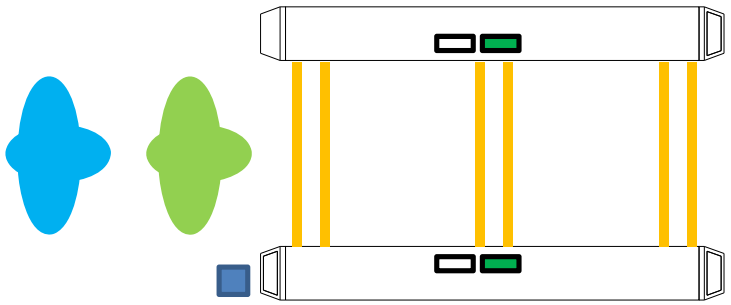

Tailgating detect when sensor is block by object (or a person) as shown below.

Pictogram Red will blinking and buzzer will switch ON.

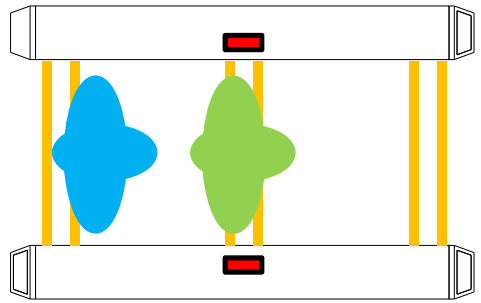

**6.2.2.4 Wrong Way**

Wrong will detect when sensor is being block as below or vice versa mode of direction.

Pictogram will start to blink RED and buzzer will be alarmed.

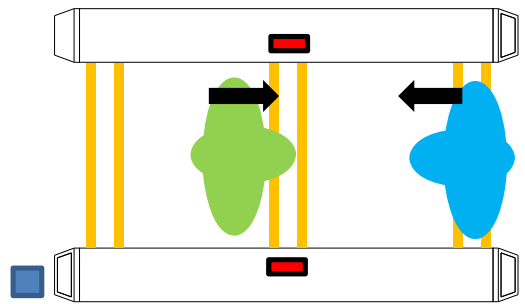

### 6.2.2.5 Intrusion

When intrusion detected, pictogram will blink RED and buzzer will be alarmed

Intrusion will be detected as follows.

- A person enters (regardless of direction) without a valid signal

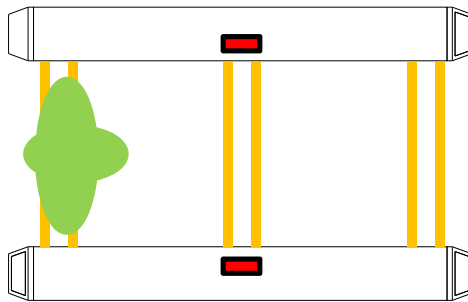

- A person enters (regardless of direction) but moves in an abnormal way, for example, the person is about to leave the gate with one arm or other object still blocking the sensor highlighted in red below

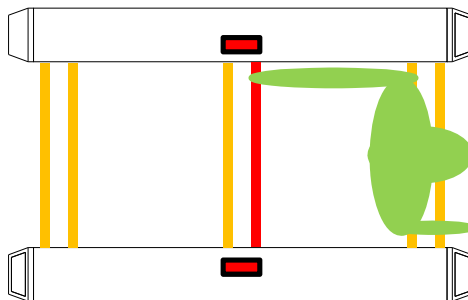

**7 MAINTENANCE**

**Table maintenance schedule**

<b>Interval</b>	<b>Maintenance work</b>	<b>To be carried out by</b>
Every 3 month	Check censor alignment only	Trained Operator / Facilities / Technician
	General cleaning of sensor hole	Trained Operator / Facilities / Technician
	General clearing of external housing / polishing	Trained Operator / Facilities / Technician
	Check wire and cabling termination	Trained Operator / Facilities / Technician
	Visual inspect the condition of Pictogram LED and the Gate end display	Trained Operator / Facilities / Technician

## 8 MALFUNCTIONS

This chapter describes possible causes of malfunctions and troubleshooting tasks.

Reduce the maintenance intervals if similar malfunctions occur repeatedly due to above-average intensive use so that the intervals correspond to the actual load.

Contact the manufacturer in case of malfunctions that cannot be repaired by means of the following information.

### 8.1 Malfunction table – Gates

Malfunction	Possible cause	Corrective action	To be carried out by
Buzzer keep switch ON even after hold open time	-Sensor is out of alignment  -Sensor is faulty  -Sensor hole has been obstruct by dirt	-Check sensor condition and align accordingly  -Replace sensor  -Clearing require	Trained Technician
No Buzzer sound despite fraud detected	-Buzzer is faulty	-Replace buzzer	Trained Technician
Buzzer is alarmed but pictogram did not blinking RED LED	-RED LED is faulty	-Replace RED LED	Trained Technician
Pictogram GREEN LED did not ON despite a valid access signal	-GREEN LED is faulty	-Replace GREEN LED	Trained Technician
Pictogram RED and GREEN is always OFF	-Both LED is faulty  -power supplies 12vdc is faulty  -loose wire	-Replace LED  -replace 12vdc power supplies  -check all wiring	Trained Technician





Malfunction	Possible cause	Corrective action	To be carried out by
Valid card accessing the reader however gate is not responding	<ul style="list-style-type: none"> <li>-problem on the access control system and control signal</li> <li>-loosen cabling</li> </ul>	<ul style="list-style-type: none"> <li>-Contact access control system vendor</li> </ul>	Trained Technician
MOB pedestrian gate not working	<ul style="list-style-type: none"> <li>-MBC 110 logic controller not function/faulty</li> <li>-MBC 120 I/O box not function</li> <li>-24VDC power supplies is faulty</li> </ul>	<ul style="list-style-type: none"> <li>-Check the 24vdc power to the MBC 110</li> <li>-Check the 24vdc power to the MBC 120</li> <li>-Check CAN bus connection</li> <li>-Replace power supplier 24vdc is found faulty</li> </ul>	Trained Technician
Gate End Display does not work.	<ul style="list-style-type: none"> <li>-Incorrect connection of the Gate End Display.</li> <li>-GED is faulty</li> <li>-power supplies is faulty</li> <li>-MBC 110 is faulty</li> </ul>	<ul style="list-style-type: none"> <li>-Check wiring and connection of the Gate End Display.</li> <li>-replace GED</li> <li>-replace 24vdc power supplies</li> <li>-replace MBC 110</li> </ul>	Trained Technician

**9 PARE PARTS**

Following spare parts are available:

Part number	Description	Picture
MPE A37320119	PE beam pair Tx/Rx PNP	
	24VDC power supplies	
	12VDC power supplies	
MBC-110B-F110-5007	Logic controller including software	
MBC-120B-F000	I/O box 30V	

Part number	Description	Picture
MPR A33755003 LOC	Gate end display	
Buzz	Buzzer	
SMD LED	LED Green / Red	

Magnetic Control Systems Sdn Bhd  
 No 17 Jalan Anggerik Mokara 31/54, Kota Kemuning  
 40460 Shah Alam, Selangor.  
 Tel: 03 5123 0033 / Fax: 03 5124 0500



**10 ELECTRICAL SCHEMATIC DIAGRAM – AT ATTACHMENT**



No 17 Jalan Angeerik Mokara 31/54  
Kota Kemuning, 40460 Shah Alam  
Selangor D.E  
www.ac-magnetic.com

Model : MOB 112  
Customer: PERODUA

				MOB 112		TITLE PAGE		=Master +	
Version	Project	Date	Name						Page 1

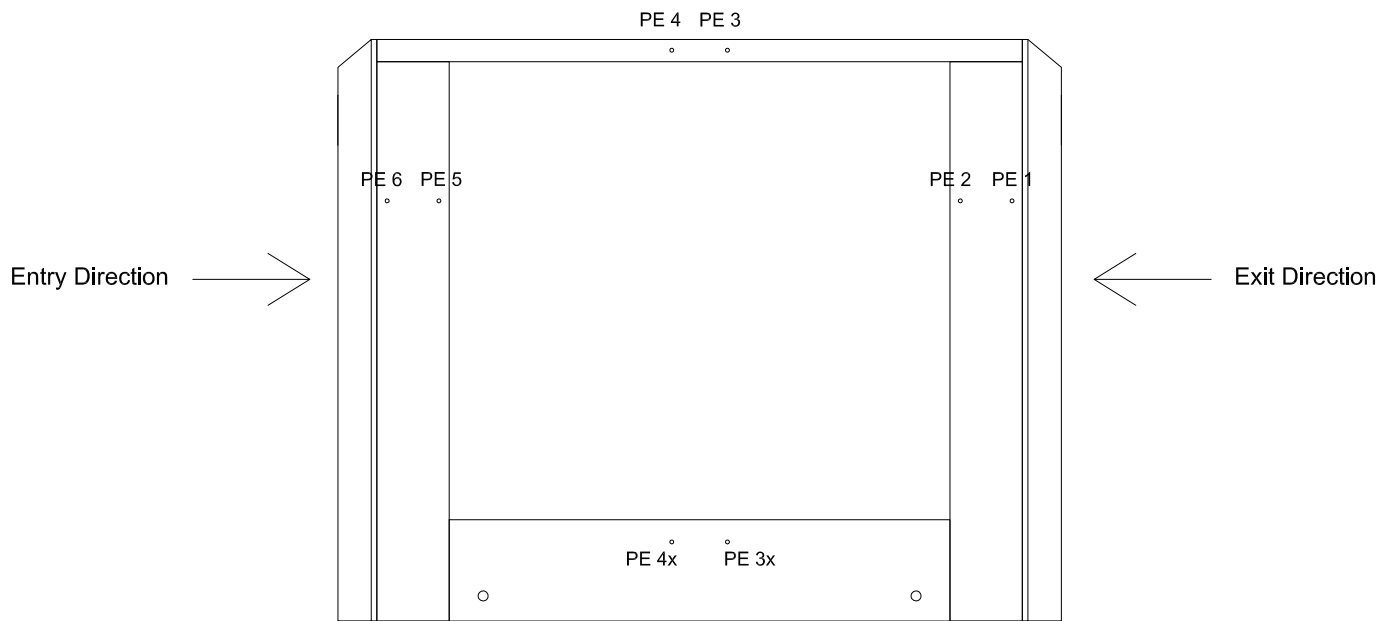
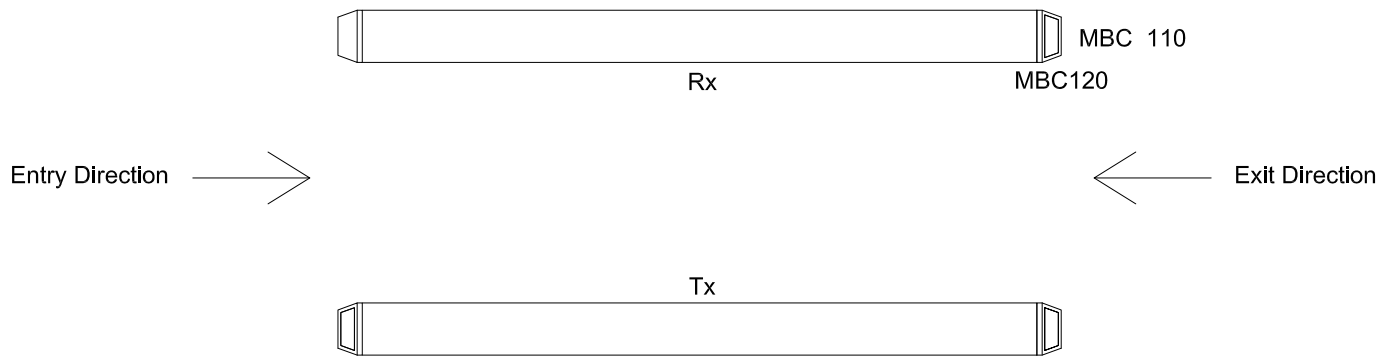

				MOB 112
Version	Project	Date	Name	

MOB 112



Layout

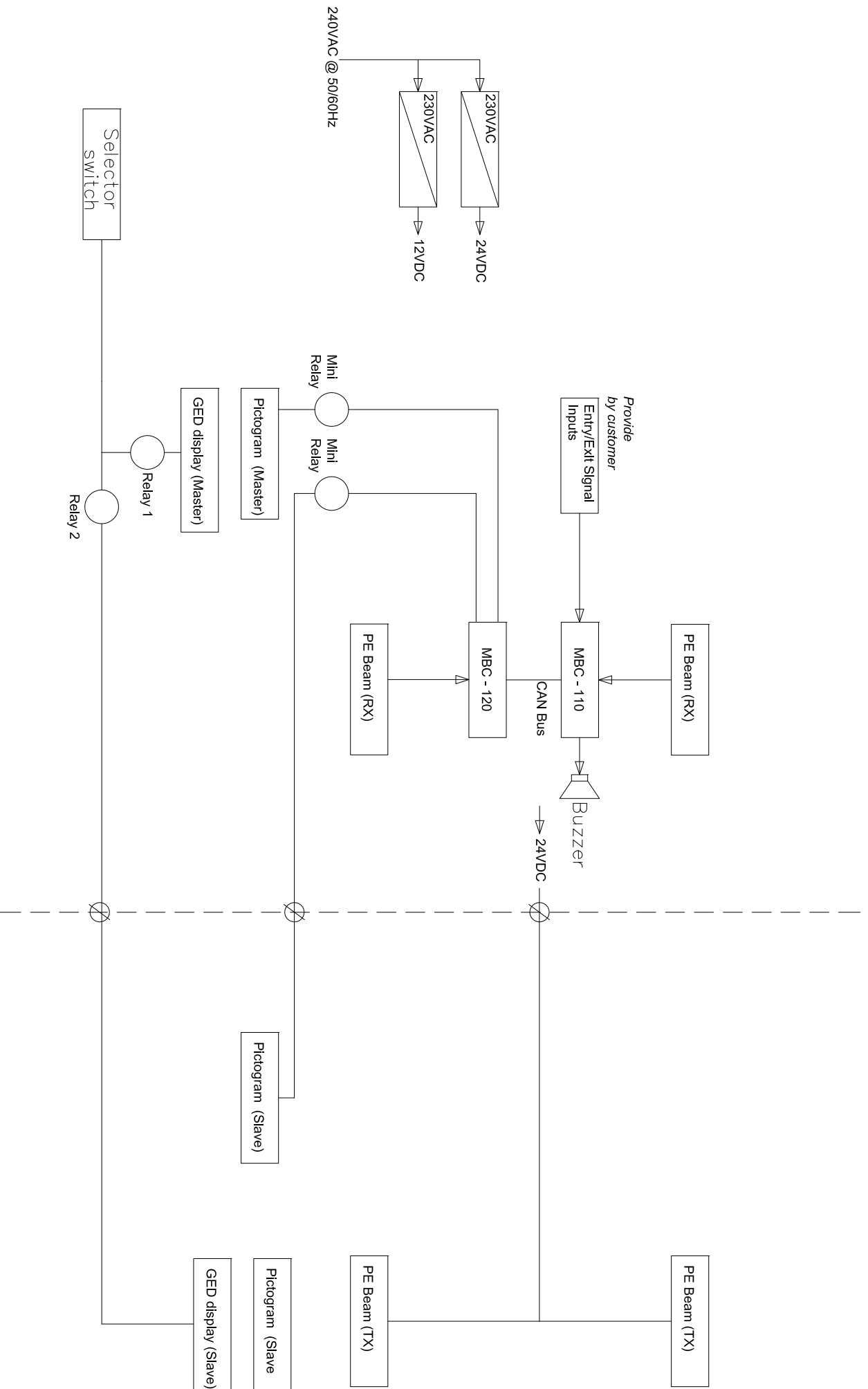

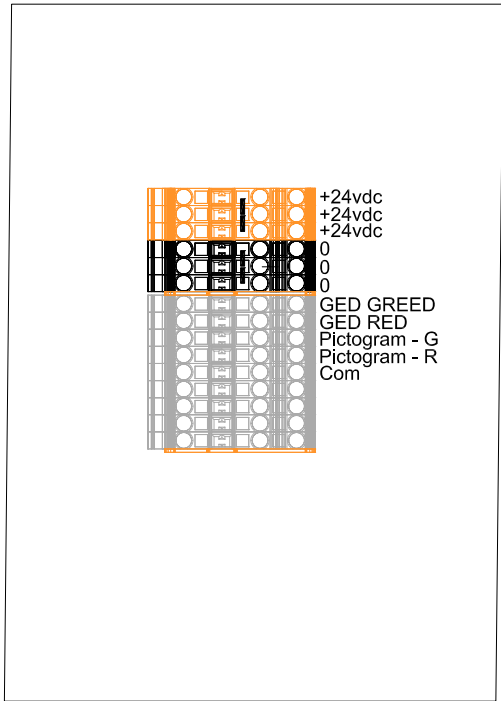

SLAVE PANEL

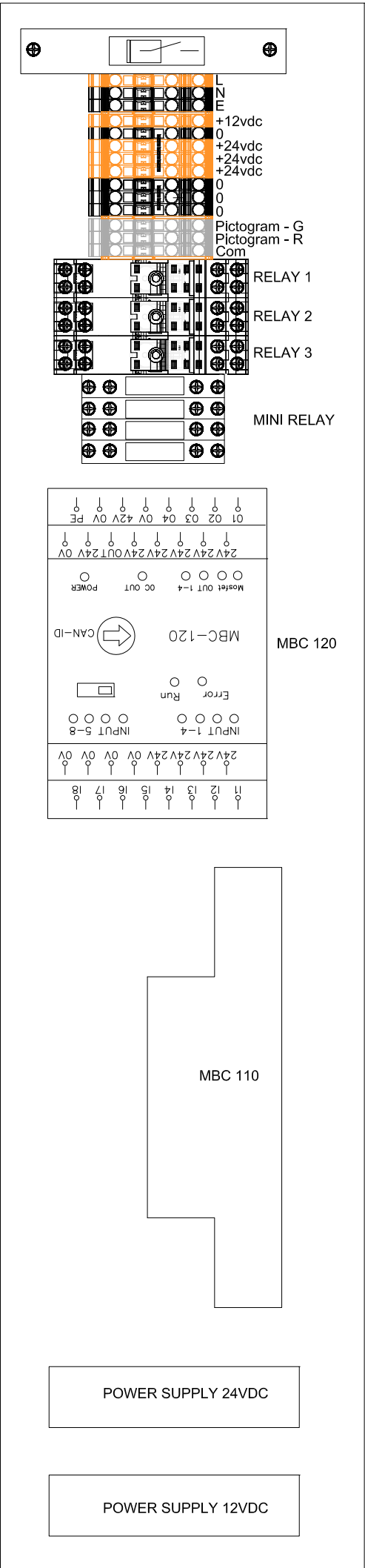

MASTER PANEL

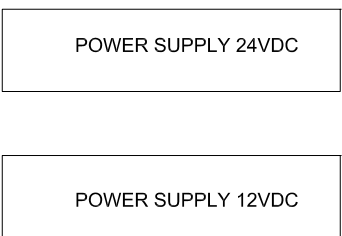

Version	Project	Date	Name	MOB 112		COMPONENT	Master	Page 4



CROSSING CABLE

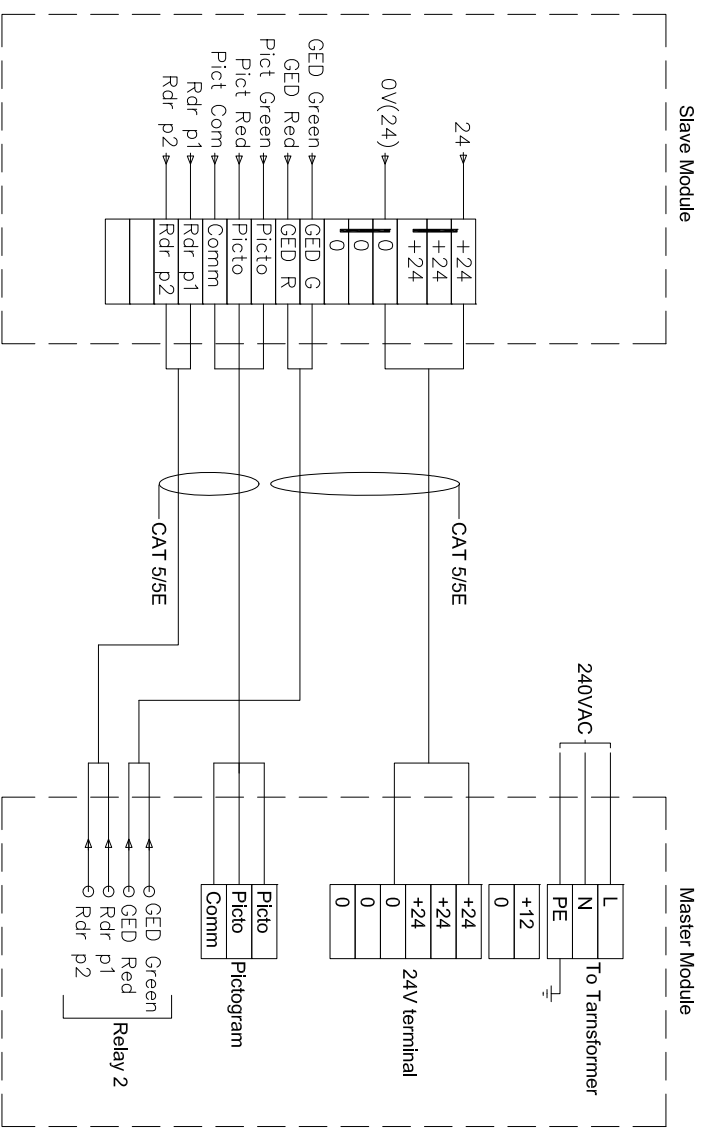

MOB 112

CROSSING CABLE



Version	Project	Date	Name

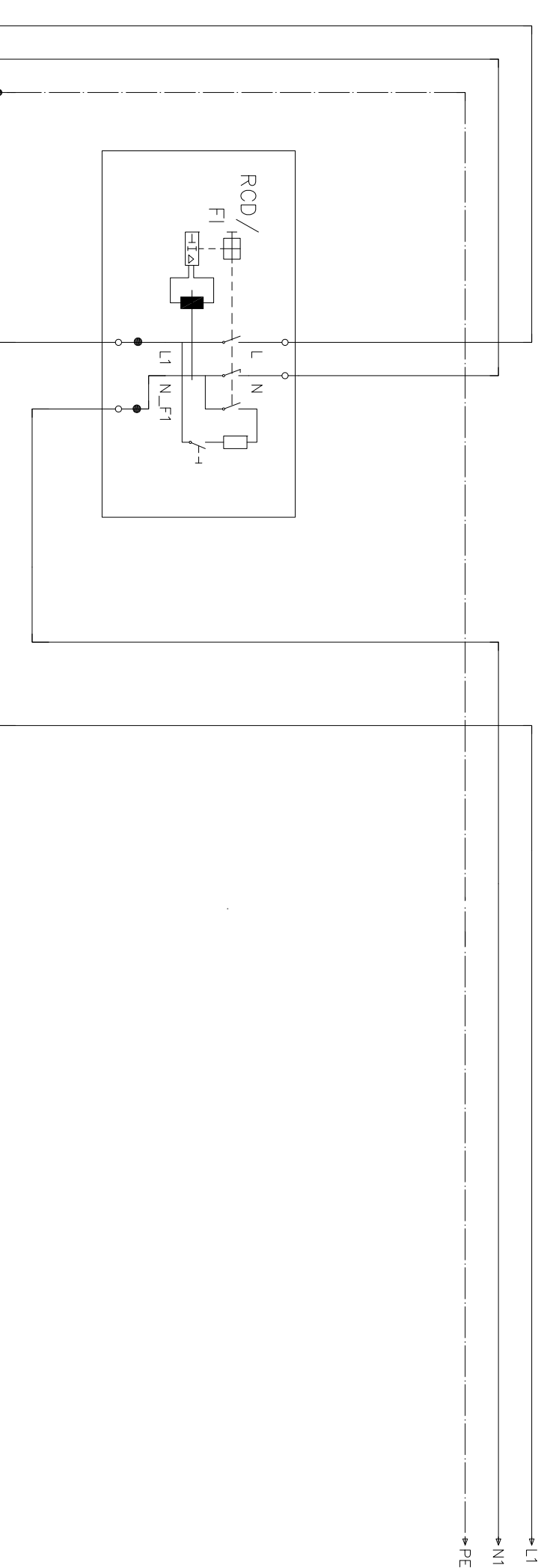

mains 230V AC, 50Hz  
16A

Version	Project	Date	Name	MOB 112	 MAGNETIC AUTOCONTROL™	MASTER Incoming Power	Master +	Page 6

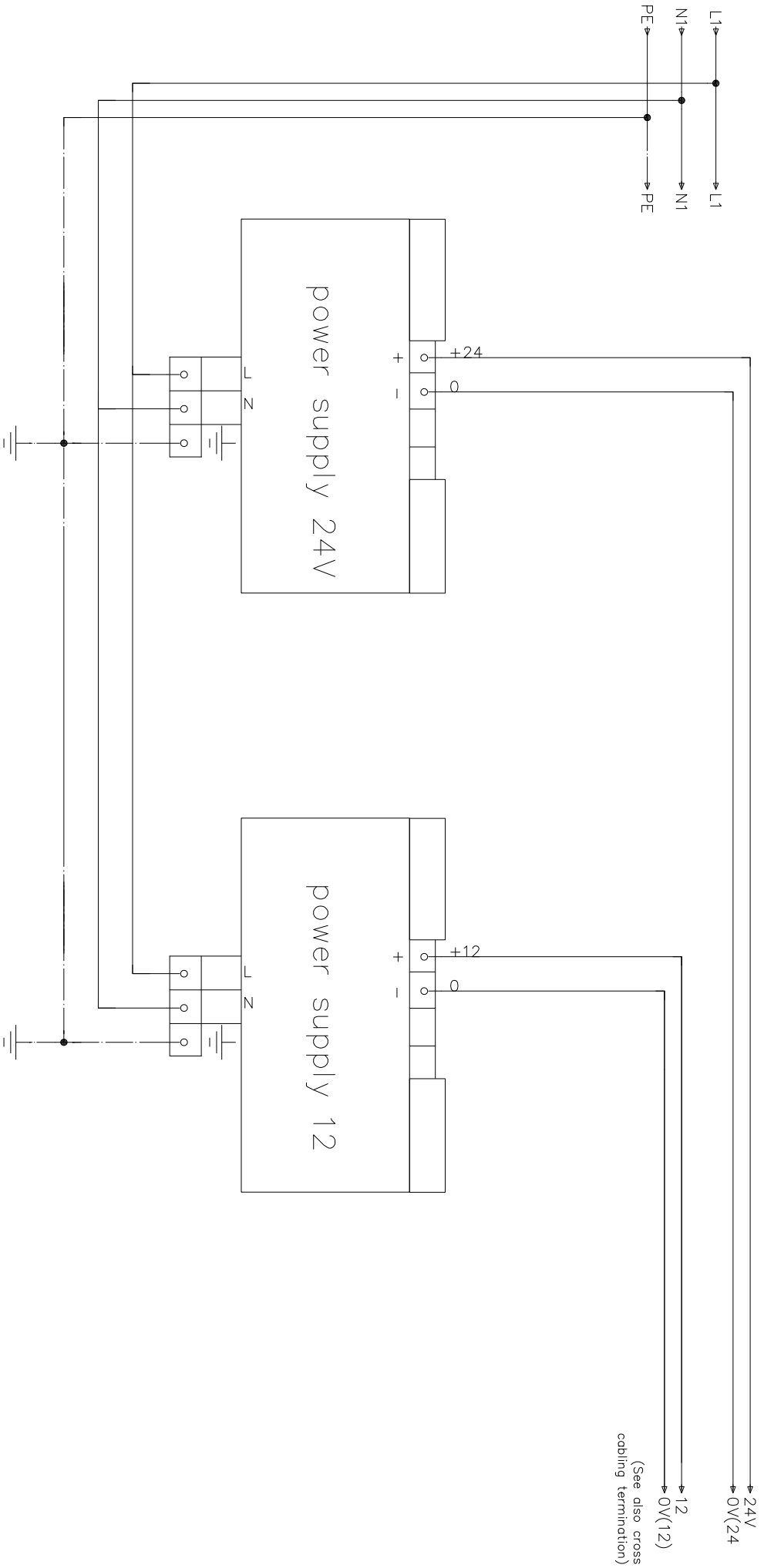

Version		Date		Name	



MASTER  
Power Supply Unit

MASTER  
Power Supply Unit

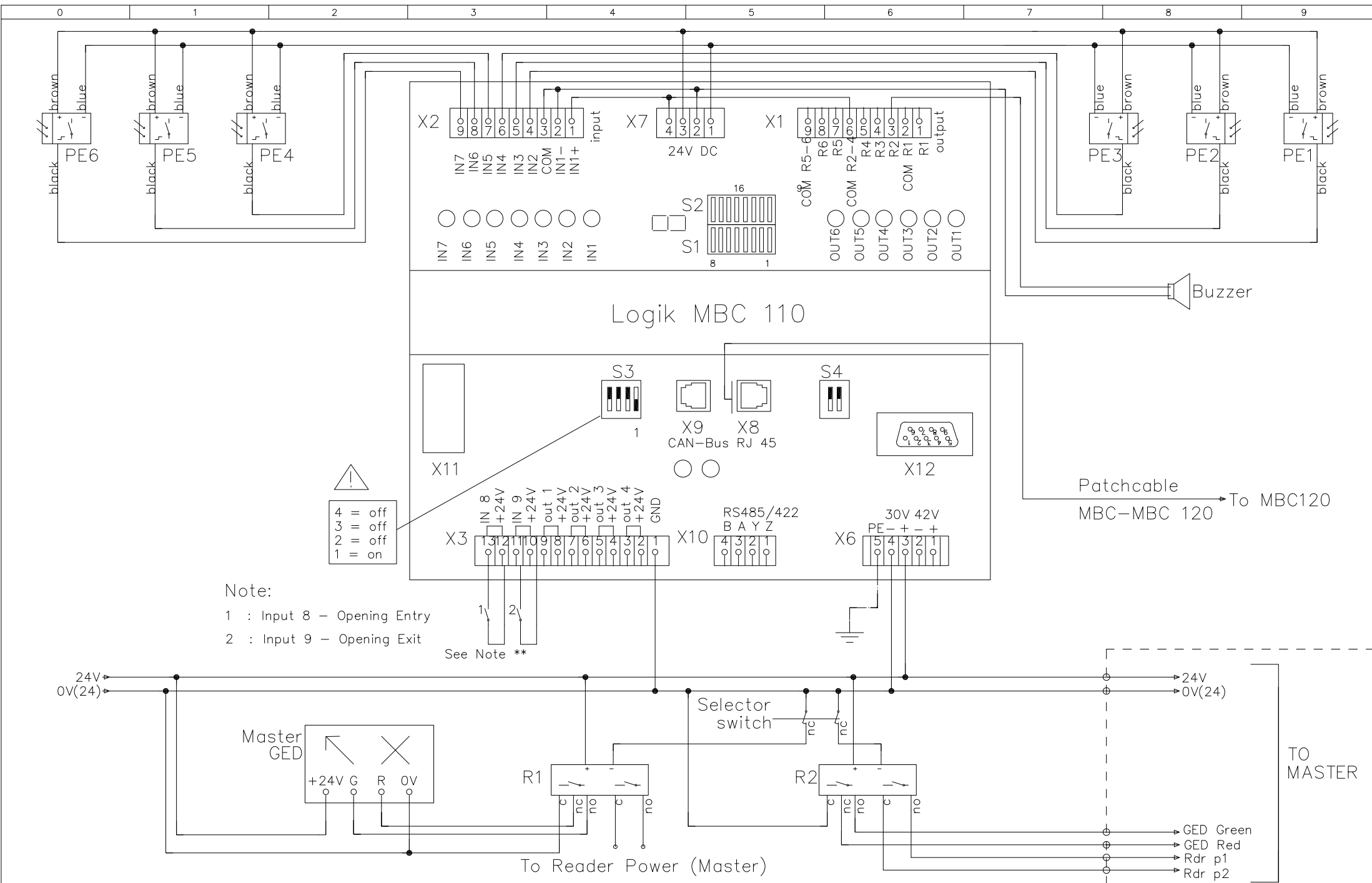

Note:  
 4 = off  
 3 = off  
 2 = off  
 1 = on

1 : Input 8 - Opening Entry  
 2 : Input 9 - Opening Exit

See Note \*\*

To Reader Power (Master)

TO MASTER

light beam receivers PE3x and PE4x

Master Pictogram

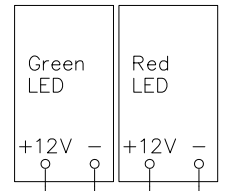

12V  
0V(12)

Miniature Relay

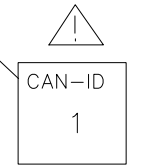
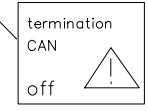
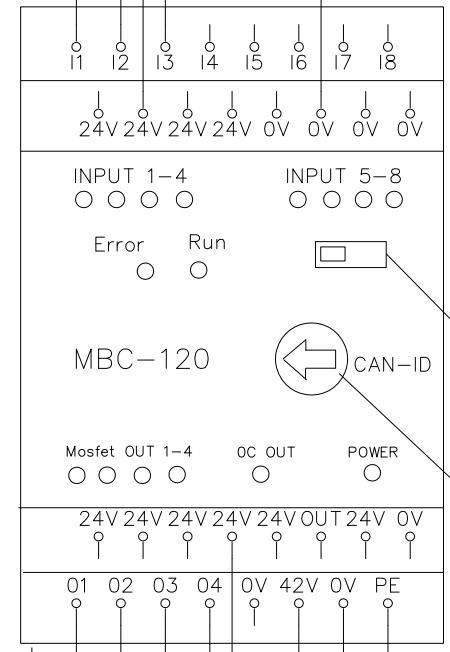
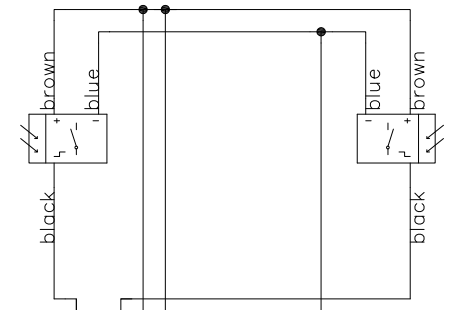
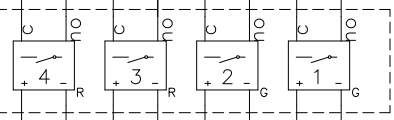

Patchcable (CAN BUS) From-MBC110

24V  
0V(24)

light beam transmitters PE 1 – PE 6

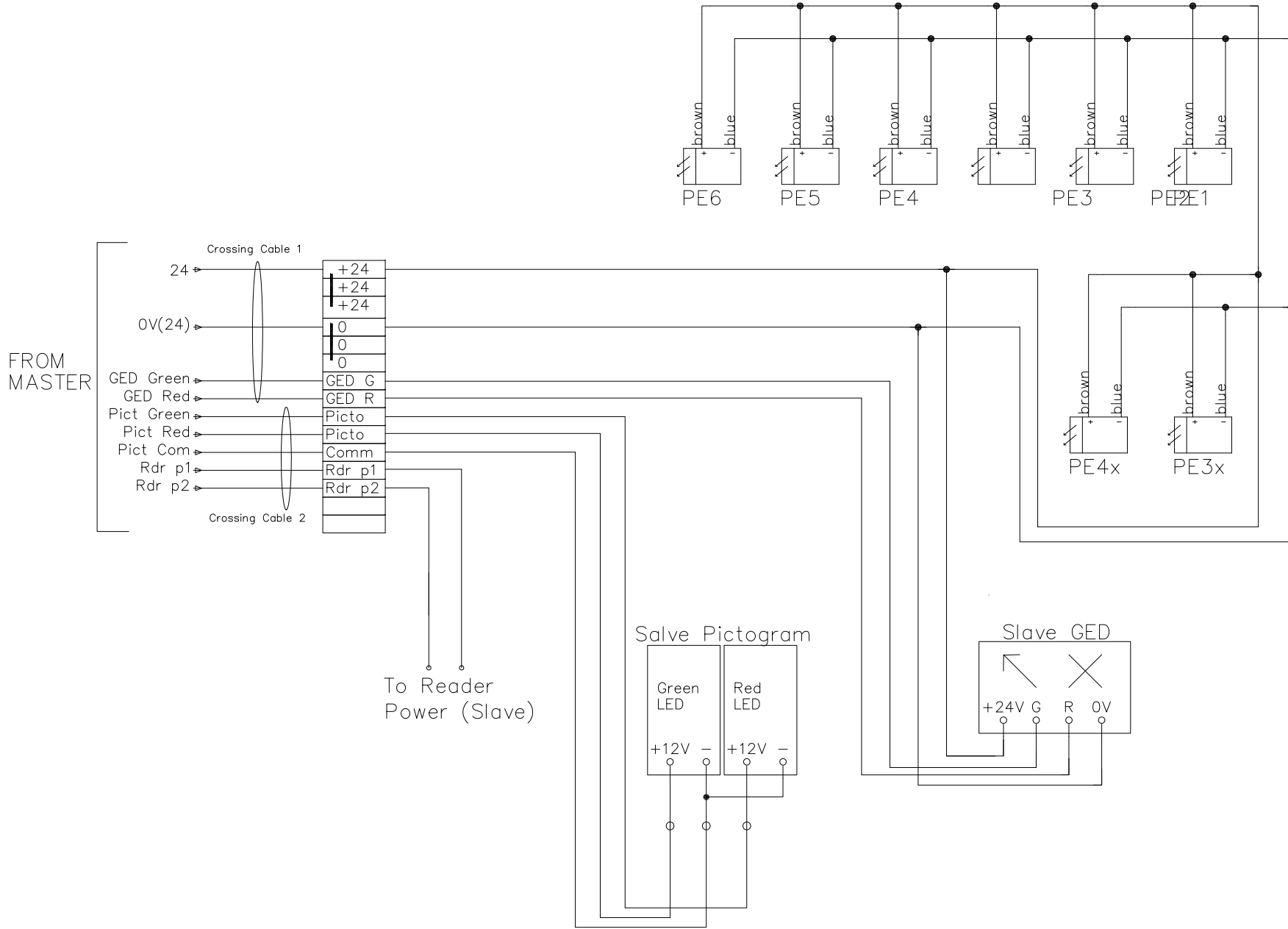

MOB 112



SLAVE

=

+